

MIDLAND G9 PRO

DUAL BAND (PMR446-LPD) TRANSCEIVER

› INSTRUCTION GUIDE



Coverage*



* Depending on terrain

MIDLAND[®]

Index

Content	4
Coverage/range	4
Batteries and battery compartment	4
Warnings	5
Features	6
Main characteristics	7
Description of the controls and functions	8
Display	8
Radio	10
Operations	12
Turning on/off	12
Selecting the PMR446 or LDP band	12
Selecting the PMR446 bands - 24CH or 32CH	12
Displaying the channel/sub audio tone	13
Transmission and reception	13
Transmitting TOT Setting	13
VOLUME adjustment	13

“CALL”	13
“Emergency”	13
MON (Monitor) function / Squelch	14
Scanning all the channels	14
Channel selection	15
CTCSS/DCS tone setting	15
Vibra-Call function	18
CALL feature	18
ROGER BEEP (End transmission tone)	19
Keypad Beep	19
Emergency Call function	19
Activating / Deactivating the Emergency feature	20
Changing the emergency channel	20
Dual Watch	21
Automatic Out-of-Range	21
Display illumination	22
Power save	22
Technical specifications	26

Thanks for choosing Midland! **Midland G9 PRO** is a portable transceiver that is free use in almost all European countries.

Content

N° 1 **Midland G9 PRO**

N° 1 Single desktop charger

N° 1 Wall adaptor

N° 4 1800 mAh AA NiMH rechargeable batteries

N° 1 Belt clip

Coverage/range

The maximum range depends on terrain condition and is obtained during use in an open space.

The only limitation to maximum possible range are environmental factors such as blockage caused by trees, buildings, or other obstructions. Inside a car or a metallic constructions, the range can be reduced. Normally the coverage in the city, with buildings or other obstructions is about **1 or 2 Km**. In open space but with obstructions like trees, leaves or houses the maximum possible range is about **4-6 Km**. In open space, without obstructions and in sight, like for example in mountain, the coverage can be more than **12 Km**.

Batteries and battery compartment

The transceiver accepts the following batteries:

- 4 rechargeable batteries supplied in the package
- 4 x AA alkaline batteries (optional)
- Ni-Mh battery pack model PB-ATL/G7 (optional)
- Li-Ion battery pack model PB-PRO (optional)

To open the battery compartment: with the back of the radio facing you, unhook the battery holder in the lower part of the radio and gently slide the cover. Insert the battery observing the polarity and place the cover again.

Attention: the batteries must be recharged before the first use.

Warnings

- **BATTERIES** - Strictly follow all the warnings on the batteries stated in the chapters concerning the recharge.
- **Do not open the radio for any reason!** The radio's precision mechanics and electronics require experience and specialized equipment; for the same reason, the radio should under no circumstances be realigned as it has already been calibrated for maximum performance. Unauthorized opening of the transceiver will void the warranty.
- Do not use detergents, alcohol, solvents, or abrasives to clean the equipment. Just use a soft, clean cloth. If the radio is very dirty, slightly dampen the cloth with a mixture of water and a neutral soap.

Features

- **Extended PMR446 band:** thanks to a new procedure described here after, it is possible to operate on the traditional PMR446 band or on a new one (further 8 PMR446 channels).
- **Side Tone:** End transmission noise muffler
- **“Dual PTT” feature for high or low output power.** Midland **G9 PRO** is equipped with a Dual PTT key. Thanks to this feature, it is possible to use the high power only when it is really necessary, enabling in this way a high reduction of the battery consumption.
- **“Emergency CALL” feature.** Midland **G9 PRO** is supplied with a channel dedicated to the emergencies. Radio communications usually happen between two or more users which are tuned on the same channel: it's not possible to transmit or receive to/from different channels. But thanks to the “Emergency” function, you can also keep a check on the emergency channel: all users having a Midland **G9 PRO** can communicate on the tuned channel and at the same time can receive/transmit Emergency messages on the dedicated channel. Simply keep pressed the **+/EMG** button for 3 seconds and an emergency **CALL** will be sent to all the **G9 PRO** within the range: they will be automatically tuned on the “EC” channel (Emergency Channel).
- **“Manual Out of range” feature:** just press twice the **+/EMG** button and you will verify whether there are some radios within the range of your equipment.
- **“Vox TalkBack” feature:** if one radio is continuously transmitting in VOX, the Vox TB will automatically stop the transmission after 20” to allow the transmission to the other users as well.

Main characteristics

- 8 new PMR446 channels
- 32 PMR446 channels (16+16 pre-programmed)
- Extended frequency band: from 446.00625 to 446.19375MHz
- Extra loud speaker
- Wide LCD display
- Weatherproof IPX4
- Dual PTT for high/low output power transmission
- Emergency call function
- Side Tone
- 38 CTCSS tones/104 DCS codes
- VOX adjustable in 3 levels and with “TalkBack”
- Power supply: 4 x 1800mAh AA Ni-MH batteries, battery pack 800mAh or Li-Ion battery pack 1200mAh (optional)
- High/Low power
- VibraCALL
- Keypad lock
- Dual Watch
- SCAN
- Monitor
- Out of range control
- Auto power save: automatic current economy circuit
- Low battery indicator
- Power: 500mW (PMR446); 10mW (LPD)
- Operating temperature: from -20° to +55° C
- 2pin accessory plug

Description of the controls and functions

Display

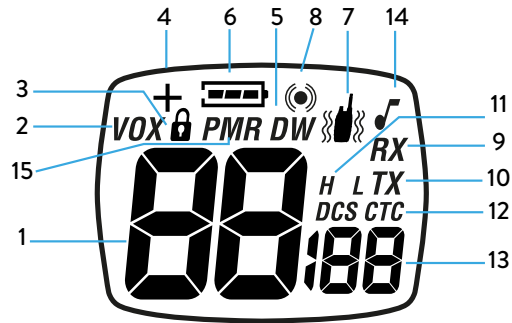

Your **Midland G9 PRO** keeps you constantly updated about its operational status through a Liquid Crystal Display (LCD). The symbols and their corresponding parameters that may appear, according to the operational status of the device, are described as follows:

1.	88	These two large digits indicate the selected channel
2.	VOX	VOX function activated
3.	🔒	This symbol appears when the keypad lock is activated
4.	+	Emergency function activated
5.	DW	Dual Watch activated
6.	🔋	Indicates the battery status
7.	👤	Vibra-Call function activated
8.	📶	Indicates if the Automatic Out of Range function loses contact with the other radios
9.	RX	Reception mode
10.	TX	Indicates the transmission (PTT pressed)
11.	H (High) L (Low)	High or low power selection. The output power of the big PTT depends on your selection
12.	DCS CTC	Indicate the type of sub audio tone selected
13.	188	These three small digits indicate the code of the CTCSS/DCS tones selected (1-38 / 1-104)
14.	🔔	Roger Beep activated
15.	PMR	This symbol indicates that the radio is operating on the new PMR446 channels

Radio

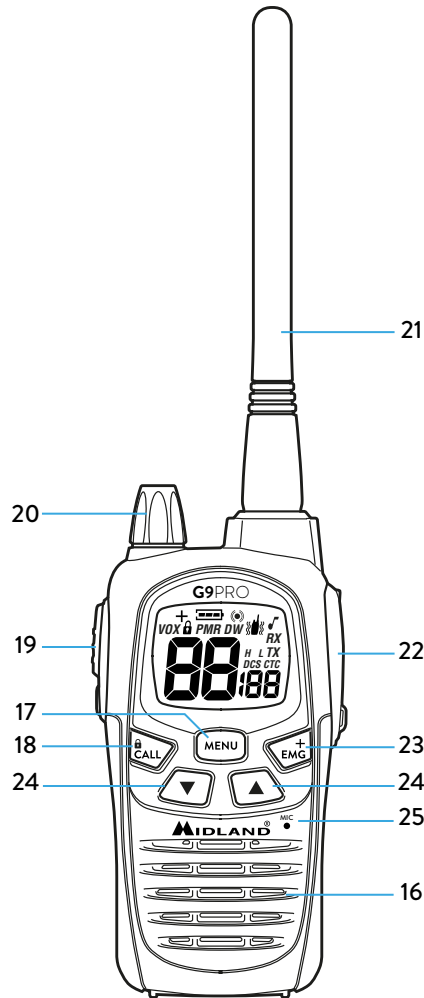

Refer to this picture to identify the various parts of the device

- | | | |
|-----|----------------------------|---|
| 16. | Built-in speaker | Here is where the speaker is housed. |
| 17. | MENU button | Press this button to enter the radio's MENU . |
| 18. | CALL/PTT button | To send a CALL on the selected channel. If you keep it pressed for about 5 seconds, the keypad lock is activated. |
| 19. | PTT (push to talk) | The PTT key has a dual function, as it is composed by 2 parts: the larger and bigger side of the PTT key, allows the transceiver to send with high or low power (depending on the setting of the MENU); while the small PTT (Boost) allows the transceiver to transmit always with high power. |
| 20. | VOLUME knob | On/off and VOLUME adjustment. |
| 21. | ANTENNA | Receives and transmits radio signals. |
| 22. | Accessory socket | (under protective cover) To connect to external audio devices such as microphones, chargers, etc. (2pin type) |
| 23. | +/EMG button | To activate the Emergency and the Manual Out of range functions. |
| 24. | ▲ ▼ buttons | To change the setting within the MENU |
| 25. | Built-in microphone | Here is where sound is picked up by the microphone. |

Operations

Turning on/off

To turn on the transceiver, turn the **VOLUME** knob clockwise until you hear it clicks. To turn off the transceiver, turn the knob counter-clockwise.

Selecting the PMR446 or LDP band

Midland G9 PRO (Dual band) is pre-set at factory on the PMR446 band.

To switch to the LPD band, keep pressed the **MENU** button until the LPD shows channel '1'.

To return to the PMR446 band, keep pressed the **MENU** button again, until the LCD shows 'P1'.

This procedure disables the “+” function; therefore if you change the frequency band, remember to activate the Emergency function again (see paragraph “Emergency call function”).

Selecting the PMR446 bands - 24CH or 32CH

G9 PRO can operate on two PMR446 bands thanks to a simple procedure described in this chapter: a traditional band with 24 channels and a new one with 32 channels.

- With the **24 channels** it is possible to communicate with all radios working on the operative band 446Mhz-446.1Mhz.
- **While with the 32 channels, the operating band is extended up to 446.2Mhz.**

When **G9 PRO** is set on the “new channels”, the display will show “PMR”.

How to activate the PMR446 bands

- Switch off the radio
- Turn it on by pressing **MENU** and **+/EMG**
- The display will show “- _ -”
- Press the following keys in the correct sequence: **▼** - **MENU** - **▲**; the symbol “- _ -” on the display will be replaced by a series of “o”.

In case of wrong sequence, **G9 PRO** will exit the procedure

- At the end of the sequence, the display will show the frequency band currently in use. Now you can select “P8”(traditional band) or “P16”(new band) by means of the **▲/▼** controls
- Press **PTT** to confirm your selection

Displaying the channel/sub audio tone

To momentarily display the PMR446 channel and the subaudio tone used in the pre-set channels, go to the desired channel (from 9p to 24p - traditional band) or from 17p to 32p (new band) and keep pressed the **▼** for 3 seconds.

Transmission and reception

To transmit keep the **PTT button** firmly pressed (it is not important what part of it). Wait for a fraction of a second then speak normally in the direction of the microphone; TX will appear on the display.

When you have finished, release the **PTT**.

When the radio is in reception mode (**PTT** released) you will automatically receive any communication. RX will be displayed.

By default the output power set is “H-high”, so independently on which PTT key you press (small or big)the transmission will be with high power. If you use an external microphone, the PTT on it will follow the same PTT setting of the radio.

Transmitting TOT Setting

The TOT function is used to prevent a too long transmission. This function temporarily blocks transmissions if the radio has been used beyond the maximum time permitted. Once reached the preset timer, the radio will be forced in reception mode.

VOLUME adjustment

Rotate the **VOLUME** knob till you reach the desired level.

“CALL”

Push the **CALL** button and you will send an audio signal to the users tuned on the same channel; you can choose amongst different **CALL** tones.

“Emergency”

When the Emergency function is enabled (+ blinks on the display) keep pressed **+/EMG** for 3 seconds and you send an emergency call to the other **G9 PRO** within your range.

The Emergency function is activated by default.

Keypad lock

Keep pressed **CALL/🔒** for about 5 seconds. and **🔒** will be displayed as confirmation. Only **PTT**, **+/EMG** and **CALL/🔒** remain active. To disable this function, keep pressed again **CALL/🔒** for 5 seconds approx.

MON (Monitor) function / Squelch

The **Monitor** button is for temporarily excluding (opening) the squelch, in order to listen to signals that are too weak to keep the squelch permanently opened. To activate the monitor function, keep pressed for about 2 seconds both **▲▼** at the same time. Follow the same procedure to deactivate the function, or switch off and on the radio.

When MON is active, you will probably hear a constant background noise.

You can activate the Monitor feature only if the “Emergency” function is disabled.

Scanning all the channels

Midland G9 PRO can automatically search for signals throughout the bands by scanning the channels in rapid sequence. This function is useful to find out any active channel.

When a signal is detected, the scanning pauses on that channel for 5 seconds. Press **▲** for 2 seconds: the scanning will start.

To stop it, push **PTT**: the **Midland G9 PRO** will go back to the channel from which the scanning originally started.

You can activate the scanning feature only if the “Emergency” function is disabled.

“MENU” key

The following features can be selected by using the “MENU” button:

- › Channel selection
- › CTCSS tone setting
- › DCS tone setting
- › High/low power selection (only in the PMR446 band)
- › VOX
- › VibraCALL function
- › Call melodies
- › Roger Beep
- › Keypad Beep
- › Emergency channel
- › Dual Watch function
- › Out of Range

Channel selection

1. Press the **MENU** button. The number of the channel will start flashing on the display.
2. Press the scroll buttons **▲▼** till you select the desired channel.
PMR446 traditional band: from P1 to P8 and from 9p to 24p (pre-set)
PMR446 new band: from 1 to 16 and from 17p to 32p (pre-set)
LPD: from 1 to 69.
To switch from PMR to LPD channels, keep pressed the **MENU** button for 3 seconds.
3. Press the **PTT** button to confirm, or wait for 5 seconds.

Channel P8 has been set at factory for the “Emergency” function; we suggest that you do not use it for general communications!

CTCSS/DCS tone setting

CTCSS and DCS tones are similar to access codes and enable the radio to communicate only with the users that are tuned on the same channel and have set the same code. For each channel, you can set up to 38 CTCSS and 104 DCS tones.

These tones can be set on the following channels:

- On the 8 main PMR446 channels (from P1 to P8) and on the 69 LPD channels.

The pre-set channels from 9p to 24p and from 17p to 32p cannot be modified.

Activating the CTCSS tones:

1. Turn on the unit.
2. Select the desired channel by pushing the **MENU** button and the **▲▼** channels.
3. Press the **MENU** button till the display shows CTC and the CTCSS tone blinks on the right (“of”= no code – default condition).
4. Select the desired CTCSS tone by pushing **▲▼**.
5. To confirm the setting, push **PTT** or wait for 5 seconds.

Deactivating the CTCSS tones:

If you don't want to use the CTCSS tones, follow these steps:

1. Select the desired channel
2. Press the **MENU** key till the display shows the CTCSS tone blinking on the left;
3. Select “of” by means of **▲▼**.

Activating the DCS codes:

1. Turn on the unit.
2. Select the desired channel by pressing **MENU** and **▲▼** keys.
3. Push the **MENU** button again till the display shows DCS and the tone code blinks on the right (“of”=no code – default condition).
4. Select the desired DCS code by pushing **▲▼**.
5. To confirm the setting, press the **PTT** or wait for 5 seconds.

Channel P8 with DCS tone 50 (P850) has been set at factory for the “Emergency” function; do not use it for general communications!!

Deactivating the DCS codes:

1. Select the desired channel.
2. Press the **MENU** key till the display shows the channel in use and the DCS code blinks on the right.
3. Select “of” by pushing **▲▼**.

4. Hi/low power selection (only in PMR446 channels)

1. To select the power level, press the **MENU** button till the display shows **Pr**.
 2. Use **▲▼** to select **L** (low power) or **H** (high power).
 3. To confirm your selection, push **PTT** or wait for 5 seconds.
- When the batteries are fully charged, the high power is 500 mW (ERP), while the low is 10mW (ERP).

If your radio has to operate within a short range, you can select the low power and therefore extend the battery life.

On LPD channels the output power is always 10 mW (ERP).

- **PMR446 channels:** The selection of high or low power influences the use of the PTT key. If you choose “H” (high power), by pressing the **PTT** key, regardless of what part of it, the transceiver transmits with high power. If you choose “L” (low power), by pressing the big PTT, the transceiver will transmit with low power; while by pressing the small **PTT** it will transmit with high power.
- **LPD channels:** the high/low output power selection is not available on LPD channels; so the two PTT transmit always with high power.

WARNING: to optimize the battery consumption, it is necessary to set the Output power of the menu as “L-low”. In this way, pressing the Boost PTT, you send with high power only when you really need. As by default the Output power is “H-high”; so it is really recommended to change this parameter to “L-low”.

VOX function

Midland G9 PRO enables hands free conversations through the VOX function: just speak in the direction of the microphone and the communication will be automatically activated.

The VOX sensitivity can be adjusted in 3 different levels.

You can enable the VOX function with or without accessories.

The fourth level activated is the Vox TalkBack: if one radio is continuously transmitting in VOX, the Vox TB will automatically stop the transmission after 20 seconds to allow the transmission to the other users as well.

To activate the VOX function press the **MENU** button till **VOX** appears on the display.

Use **▲▼** to select the sensitivity levels:

1. 0f: Off;
2. 1: High
3. 2: Middle
4. 3: Low
5. 4: Talk Back (with high sensitivity)

To confirm your selection, press **PTT** or wait for 5 seconds.

To disable the VOX function, follow the procedure here above indicated and select **oF**.

Vibra-Call function

Midland G9 PRO is equipped with the “Vibra-Call” feature, which provides a silent alert for incoming calls.

1. To activate this feature, press the **MENU** button until the display shows .
2. Use the **▲▼** buttons to disable or enable this feature (**on**: enables, **oF**:disables).
3. Push **PTT** [11] to confirm or wait for 5 seconds.

CALL feature

Midland G9 PRO can send 5 different **CALL** tones. To send this audio signal to other users, press the **CALL/📞** key.

To select the **CALL** tones:

1. Press **MENU**, until the display shows “**CA**” and the active tone code.
2. By pushing **▲▼** you will hear the 5 pre-set melodies.
3. Confirm by pressing **PTT** or wait for 5 seconds.

ROGER BEEP (End transmission tone)

When the **PTT** button is released, the radio will beep to confirm to other users that your transmission has finished.

In the **Midland G9 PRO** this function is factory disabled.

To activate it:

1. Press the **MENU** button until the display shows “**rb of**”;
2. Using the scroll buttons **▲▼** select “**on**” and “**rb on**” will be displayed;
3. To confirm the roger beep activation, press **PTT** or wait for 5 seconds.

Keypad Beep

Everytime a button is pressed, you will hear a beep.

To disable the beeps, follow this procedure:

1. Press **MENU**, till the display shows “**bP on**”.
2. Push **▲▼** till “**bP of**” is displayed.
3. Confirm your selection by pushing **PTT** or wait for 5 seconds.

In this way, all beeps and tones are disabled.

To enable the keypad beep, repeat this procedure and select “**bP on**”

Emergency Call function

The **Midland G9 PRO** dedicates a channel to the Emergency Calls: all the **G9 PRO** operating within your range, even if tuned on different channels, can receive/transmit Emergency messages on that channel.

If you keep pressed the **+/EMG** button, the communications automatically switch to the emergency channel (“**EC**” on the display). An audio signal will be sent and all the **G9 PRO** operating within the range will automatically go to the Emergency channel (“**EC**”).

If you have disabled this function, you won’t receive/transmit any Emergency Call.

When the radio is operating on the Emergency channel (EC displayed), all the buttons except PTT and CALL are disabled.

The **G9 PRO** will return to the channel in use after one minute from the last transmission.

To return immediately, push **+/EMG**. Now you can use all the **MENU** functions.

Activating / Deactivating the Emergency feature

When you switch on the unit, the Emergency function is activated, but you can disable and enable it again:

1. Press **MENU** till the display shows **EC on**.
2. Select **EC of** by using **▲▼**.
3. Confirm your selection by pushing **PTT** or wait for 5 seconds.

When the Emergency function is activated (+ blinking on the display) the following functions cannot be used: Scan, Monitor, Dual Watch, Out of Range.

Changing the emergency channel

The emergency channel originally preset is P8 DCS 50; but you can change it according to your needs.

Important: be sure that the Emergency function is active! (+ blinking). If you decide to change the channel dedicated to the Emergency function, do not forget to make the same change to all the radios!

1. Press the **MENU** button until the display shows **EC on**.
2. Push **MENU** again (of displayed) and select the desired channel by means of **▲▼**.
3. To confirm press **PTT** or wait for 5 seconds.

Important: be sure that the Emergency function is active! (+ blinking).

If you decide to change the channel dedicated to the Emergency function, do not forget to make the same change to all the radios!

To set again the original Emergency channel (P8 DCS 50)

1. Press the **MENU** button until the display shows **EC on**.
2. Push **MENU** again and select **of**
3. To confirm press **PTT** or wait for 5 seconds.

If you dedicate any of the standard channels to the Emergency function, remember to use it only for this purpose, otherwise you will cause interferences.

Manual Out of range function

This function allows you to know if there are any radios within your range.

By pushing **+/EMG** twice, you will send a request of acknowledge to the other **G9 PRO** operating within your range and tuned on the same channel. If any radio replies, it means that it's within your range and you will receive an audio tone for confirmation.

This function can be used only if the “Automatic Out of Range” feature is not active.

Dual Watch

The Dual Watch allows you to monitor constantly two channels of your choice at the same time.

Enabling - Disabling

1. Press the **MENU** button until the display shows **DW of**.
2. Select the second channel to monitor by pushing **▲▼**.
3. To confirm your selection, press **PTT** or wait for 5 seconds.
4. The display will alternately show the channel in use and the second channel to monitor.
5. To stop the function, simply press **MENU**.

When the transceiver detects a transmission on one of the two channels, the Dual Watch temporarily pauses, remains tuned for 5 seconds on the corresponding channel, giving the user a chance to respond to a **CALL**. After this pause, the Dual Watch starts again.

This function can be activated only if the “Emergency” feature is disabled.

Automatic Out-of-Range

By setting this mode a pair of **G9 PRO** is transmitting every 30 seconds a data control code. As soon as the contact between both units is getting lost and one radio doesn't receive this data control code twice consecutively, the icon **OUT** starts flashing in the display and you will hear a beep tone.

This function can be activated only if the “Emergency” feature is disabled.

Activating – Deactivating

1. Press **MENU** till the display shows “**OUT**” and “**Or of**”, select “**Or on**” (activated) with the ▲▼ buttons.
2. Switch off both radios.
3. Turn them on at the same time.

To disable this function:

1. Push **MENU** till “**OUT**” and “**Or on**” are displayed;
2. Select “**Or of**” (disabled) with the ▲▼ buttons.
3. Confirm your selection by pushing **PTT** or wait for 5 seconds.

Display illumination

If there is insufficient light to read the display, press briefly **+/EMG** and the display illumination will activate for about 5 seconds. Every time the **MENU** is pressed, the display will automatically light up.

Power save

The battery power saving feature enables a reduction in the consumption of up to 50%; power saving comes on automatically when the transceiver does not receive any signal for more than 7 seconds. When the batteries are discharged, the icon  appears on the display: replace the batteries or recharge the battery pack.

The power save is active only if the Emergency function is disabled.

Recharging the NIMH batteries (4 x AA)



Place your transceiver into the cradle of the desktop charger.

The recharge time depends from the recharge status and from the batteries capacity.

There's no evidence when the recharge is finished, therefore we suggest you detach the wall adaptor from the radio or remove **G9 PRO** from the desktop charger cradle once the recharge is complete.

Here below some information about the recharge time (indicative) for some batteries of different capacity:

Battery capacity mAh	Approx. recharge time (hours)
1200	5
1800	7
2100	8

-  When the radio is in the charger cradle, the processor makes a sort of checking on the battery; the led on the charger will light up for 10 seconds, then will turn off and the recharge will start.
-  The battery icon on the radio's display will be blinking for all the recharging process, as well as the red led will be lighting up on the desktop charger.

Recharging the NiMH battery pack PB-ATL/G7 800 mAh

Place your transceiver into the cradle of the desktop charger.

A complete recharge takes about 5 hours.

There's no evidence when the recharge is finished, therefore we suggest you detach the wall adaptor from the radio or remove **G9 PRO** from the desktop charger cradle after 5 hours.

 *When the radio is in the charger cradle, the processor makes a sort of checking on the battery; the led on the charger will light up for 10 seconds, then will turn off and the recharge will start; the battery icon on the radio's display will be blinking for all the recharging process, as well as the red led will be lighting up on the desktop charger.*

Recharging the Li-Ion battery pack 'PB-PRO' (optional)

Place your transceiver into the cradle of the desktop charger.

The recharge of the Li-Ion battery pack is managed by a radio processor and the battery status can be checked by the icon on the display and by the led on the desktop charger

- The recharge status is indicated by the led on the desktop charger and by the battery icon blinking on the display of the radio;
- When the recharge is complete, the led will turn off and the battery icon on the display will be full of bars and steady.

 *When the radio is in the charger cradle, the processor makes a sort of checking on the battery status: in this step, the led on the desktop charger will light up for 10 seconds, then will turn off and the recharge will start.*

 *To optimize the recharge of the Li-Ion battery pack, in the final phase the processor will alternately charge and pause for almost one minute (the led will turn off).*

 *If the radio is placed in the desktop charger switched on, when the recharge is complete the led will blink.*

Recharging process

When you place the radio into the charger cradle, at first the charger makes a sort of checking on the battery status. In this phase, the led of the desktop charger will turn on for 10 seconds, then will turn off for the following 10 seconds and will switch on again to indicate the charging process.

While the radio is being charged, the led on the desktop charger will be on and the battery icon on the display will be blinking.

When the recharge is complete, the led will switch off and the battery icon will be steady and will show all its bars.

Memory effect of rechargeable batteries

Rechargeable NiMH (Nickel-Metal-Hydrate) batteries are affected by what is known as the "memory effect". This phenomenon is associated with a drastic reduction of battery autonomy and is triggered if the batteries are regularly charged before being fully discharged and/or are not completely recharged. To avoid the memory effect:

- When possible, recharge the batteries only when they are completely discharged (until the device turns itself off during normal use)
- Do not disconnect the battery charger before the time indicated for a full battery charge.

 *The memory effect should not be confused with the normal battery life, which is 300-400 cycles of charge/discharge on average. It is completely normal for operating duty to decrease when the batteries have reached the end of their life; at this point, you will need to substitute the batteries.*

Technical specifications

Channels	G9 PRO traditional band 8+16 preprogrammed (PMR446) + 1~69 (LPD)
	G9 PRO (new band) 16+16 pre-set (PMR446) + 1-69 (LPD)
Frequency range	PMR446 traditional band 446.00625 ÷ 446.09375MHz () PMR446 new band 446.00625 / 446.19375 MHz LPD 433.075 ÷ 434.775MHz
Channel spacing	2.5 KHz (PMR446); 25 KHz (LPD)
Power supply	6+/- 10% Vdc
Temperature	from -20° to +55°C
Dimensions (w/o batteries)	64 (L)x 126 (H)x36 (D) mm
Weight (w/o batteries)	150gr
Duty cycle	TX 5%, RX 5%, stand-by 90%
Category	B
TRANSMITTER	
Output power	10 or 500 mW (Selectable)
Modulation	FM
Spurious rejection	within European legal terms

RECEIVER	
Sensitivity @ 12dB Sinad	0,35µV
Adjacent channel rejection	70dB
Audio output power	300mW @ 10% THD
LPD receiver category	3
Jack for ext.mike and recharge	stereo 2,5 mm
Jack for ext. speaker	mono 3.5 mm
Maximum transmission time in an hour	6 minutes, equivalent to a duty cycle of 10%

Specifications are subject to change without notice.

WARNING: Direct plug-in ac/dc power supply must be used for disconnecting the transceiver from the mains; the desktop charger must be positioned close to the unit and easily accessible.

Prodotto o importato da: **MIDLAND EUROPE s.r.l.**

Via R. Sevardi 7 - 42124 Reggio Emilia Italia

www.midlandreurope.com

L'uso di questo apparato può essere soggetto a restrizioni nazionali.

Prima dell'uso leggere attentamente le istruzioni.

Produced or imported by: **MIDLAND EUROPE s.r.l.**

Via R. Sevardi 7 - 42124 Mancasale Reggio Emilia Italy

Imported by: **ALAN - NEVADA UK**

Unit 1 Fitzherbert Spur Farlington Portsmouth Hants.

P06 1TT - United Kingdom

www.nevada.co.uk

The use of this transceiver can be subject to national restrictions.

Read the instructions carefully before installation and use.

Importado por: **MIDLAND IBERIA, SA**

C/Cobalt, 48 - 08940 Cornellà de Llobregat (Barcelona - España)

www.midland.es

El uso de este equipo puede estar sujeto a la obtención de la correspondiente autorización administrativa. Lea atentamente las instrucciones antes de usar el equipo.

Vertrieb durch: **ALAN ELECTRONICS GmbH**

Daimlerstraße 1K - D-63303 Dreieich Deutschland

www.alan-electronics.de

Die Benutzung dieses Handfunkgerätes ist von den landesspezifischen Bestimmungen abhängig. Vor Benutzung Bedienungsanleitung beachten.

Importé par: **ALAN FRANCE S.A.R.L.**

5, Rue Ferrie, Zac les Portes du Vexin 95300 Ennery - France

www.alan-midland.fr

L'utilisation de cet appareil peut être sujet à des restrictions nationales. Avant l'utilisation, lire les instructions.



MIDLAND®